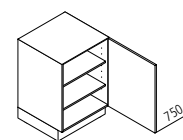
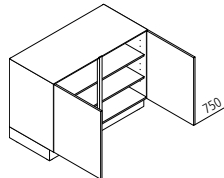
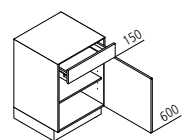
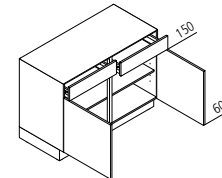
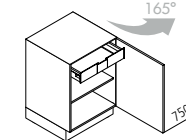
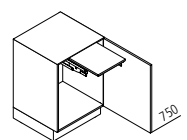
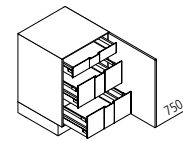
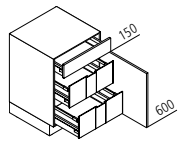
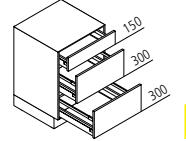
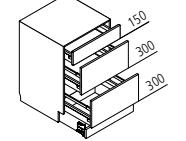
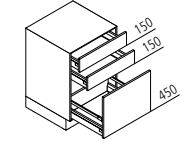
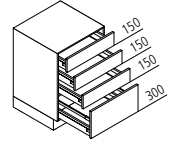
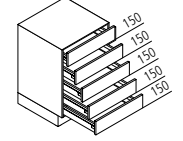
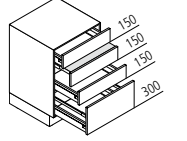
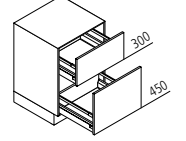
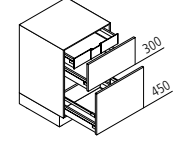
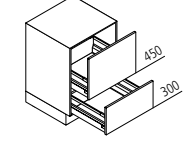
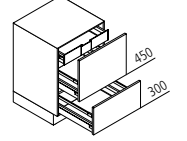

# Unterschränke

750mm

					
<b>UDD</b> Unterschränk	<b>UDD</b> Unterschränk	<b>U</b> Unterschränk	<b>U</b> Unterschränk	<b>UDDI</b> Unterschränk	<b>UBKOD</b> Brotmaschinenchränk
↔ 30/35/40/45/50/60 ↓ 75 ↙ 60/50/39	↔ 80/90/100/120 ↓ 75 ↙ 60/50/39	↔ 30/40/45/50/60 ↓ 75 ↙ 60/50/39	↔ 80/90/100/120 ↓ 75 ↙ 60/50/39	↔ 40/45/50/60 ↓ 75 ↙ 60/50	↔ 45/50/60 ↓ 75 ↙ 60

					
<b>UIDD</b> Unterschränk	<b>UI</b> Unterschränk	<b>UAK</b> Auszugsschränk	<b>UAKS</b> Auszugsschränk mit Großraumauszug	<b>UAS</b> Schubkastenschränk	<b>USA</b> Schubkastenschränk
↔ 40/45/50/60 ↓ 75 ↙ 60/50/39	↔ 40/45/50/60 ↓ 75 ↙ 60/50/39	↔ 30/40/45/50/60/80/90/100/120 ↓ 75 ↙ 60/50/75/39	↔ 60/80/90/100 ↓ 75 ↙ 60	↔ 30/40/45/50/60/80/90/100/120 ↓ 75 ↙ 60/50/75/39	↔ 30/40/45/50/60/80/90/100/120 ↓ 75 ↙ 60/50/39

					
<b>US</b> Schubkastenschränk	<b>USAP</b> Schubkastenschränk mit Arbeitstisch	<b>UZ</b> Auszugsschränk	<b>UZI</b> Auszugsschränk	<b>UAZ</b> Auszugsschränk	<b>UAZI</b> Auszugsschränk
↔ 30/40/45/50/60/80/90/100/120 ↓ 75 ↙ 60/50	↔ 60 ↓ 75 ↙ 60	↔ 30/40/45/50/60/80/90/100/120 ↓ 75 ↙ 60/50/75/39	↔ 30/40/45/50/60/80/90/100/120 ↓ 75 ↙ 60/50/75/39	↔ 30/40/45/50/60/80/90/100/120 ↓ 75 ↙ 60/50	↔ 30/40/45/50/60/80/90/100/120 ↓ 75 ↙ 60/50

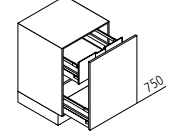
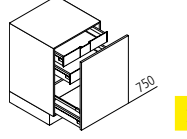
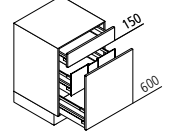
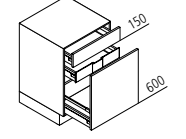
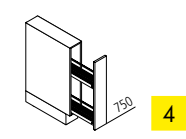
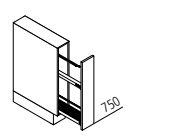
					
<b>UATDIA</b> Auszugsschränk	<b>UATD</b> Auszugsschränk	<b>UATIA</b> Auszugsschränk	<b>UAT</b> Auszugsschränk	<b>UKD</b> Stollenschränk	<b>UKTD</b> Stollenschränk mit Handtuchhalter
↔ 30/40/45/50/60 ↓ 75 ↙ 60/50	↔ 30/40/45/50/60 ↓ 75 ↙ 60/50	↔ 30/40/45/50/60/80/90/100/120 ↓ 75 ↙ 60/50	↔ 30/40/45/50/60/80/90/100/120 ↓ 75 ↙ 60/50	↔ 15 ↓ 75 ↙ 60	↔ 15 ↓ 75 ↙ 60

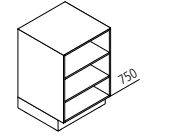
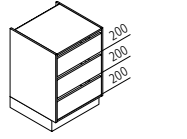
	
<b>UR</b> Unterschränk-Regal	<b>URI</b> Unterschränk-Regal mit Schubkästen
↔ 15/20/25/30/35/40/45/50/55/60 ↓ 75 ↙ 60/39	↔ 60/90 ↓ 75 ↙ 60

↔ Schrankbreite  
↓ Schrankhöhe  
↙ Planungstiefe



1 2 3 4 5

Die Unterschränke Ihrer Nolte Küche bieten Ihnen zahlreiche und äußerst flexibel gestaltete Varianten – für die perfekte Anpassung an Ihren Stauraumbedarf.

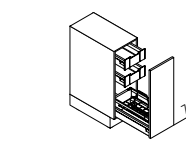
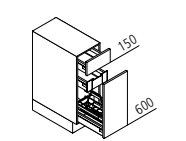
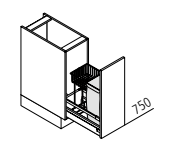
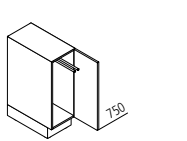
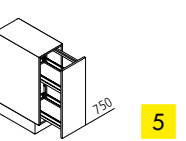
				
<b>UAID</b> Auszugsschränk	<b>UAI</b> Auszugsschränk	<b>UBD</b> Auszugsschränk mit Baguette- und Utensilieneinsatz	<b>UTD</b> Unterschränk mit Handtuchstangen	<b>UVK</b> Auszugsschränk mit Vorratskörben
↔ 30 ↓ 75 ↙ 60	↔ 30 ↓ 75 ↙ 60	↔ 30 ↓ 75 ↙ 60	↔ 30 ↓ 75 ↙ 60	↔ 30 ↓ 75 ↙ 60

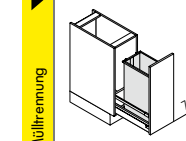
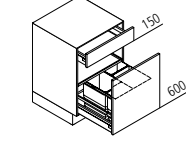
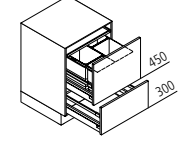
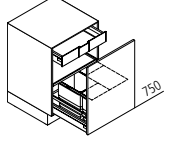
			
<b>UWSD</b> Auszugsschränk mit Behälter für Wertstoffsack	<b>UABG</b> Auszugsschränk mit Abfalleimer	<b>UABO</b> Auszugsschränk mit Abfalleimer	<b>UABDG</b> Auszugsschränk mit Abfalleimer
↔ 30 ↓ 75 ↙ 60	↔ 40/45/50/60 ↓ 75 ↙ 60	↔ 30/40/45/50/60 ↓ 75 ↙ 60	↔ 40/45/50/60 ↓ 75 ↙ 60

**Unterschränke**  
600mm | 450mm | 300mm

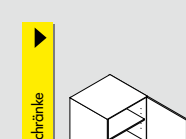
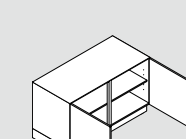
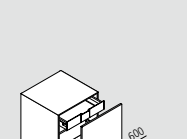
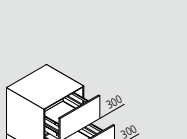
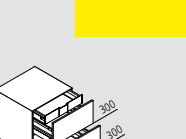
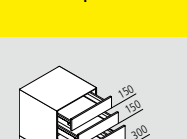
					
<b>600er Schränke</b>	<b>UDD</b> Unterschränk	<b>UATD</b> Auszugsschränk	<b>UAZ</b> Auszugsschränk	<b>UAZI</b> Auszugsschränk	<b>USA</b> Schubkastenschränk
	↔ 30/35/40/45/50/60 ↓ 60 ↙ 60/50/39	↔ 80/90/100/120 ↓ 60 ↙ 60/50/39	↔ 30/40/45/50/60/80/90/100 ↓ 60 ↙ 60/50	↔ 30/40/45/50/60/80/90/100 ↓ 60 ↙ 60/50	↔ 30/40/45/50/60/80/90/100 ↓ 60 ↙ 60/50

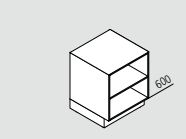
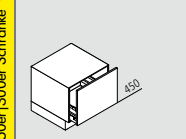
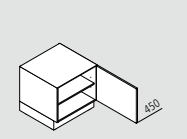
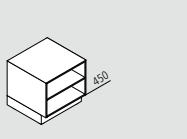
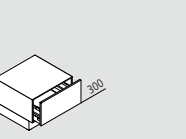
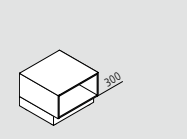

					
<b>450er/300er Schränke</b>	<b>UAK</b> Auszugsschränk	<b>UDD</b> Unterschränk	<b>UR</b> Unterschränk-Regal	<b>UAK</b> Auszugsschränk	<b>UR</b> Unterschränk-Regal
	↔ 30/40/45/50/60 ↓ 60 ↙ 60/39	↔ 30/40/45/50/60/80/90/100/120 ↓ 45 ↙ 60/50/39	↔ 30/40/45/50/60 ↓ 45 ↙ 60/39	↔ 30/40/45/50/60/80/90/100/120 ↓ 30 ↙ 60/50/39	↔ 30/40/45/50/60 ↓ 30 ↙ 60/39

# Unterschränke

750mm

Spülenschränke

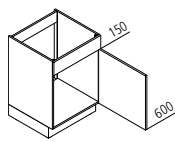

**SO Spülenunterschrank**  
 ↳ 45/50/60  
 ↓ 75  
 ↙ 60/50

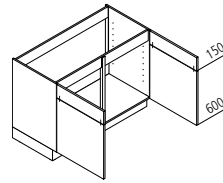

**SO Spülenunterschrank**  
 ↳ 80/90/100/120  
 ↓ 75  
 ↙ 60/50

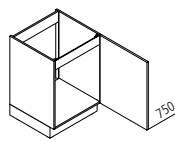

**SOD Spülenunterschrank**  
 ↳ 45/50/60  
 ↓ 75  
 ↙ 60/50

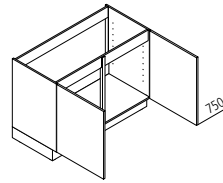

**SOD Spülenunterschrank**  
 ↳ 80/90/100/120  
 ↓ 75  
 ↙ 60/50

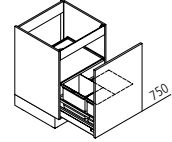

**SABD Spülenunterschrank mit Abfalltrennsystem**  
 ↳ 45/50/60  
 ↓ 75  
 ↙ 60

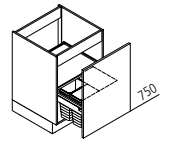

**SABHD Spülenunterschrank mit hängendem Abfalltrennsystem**  
 ↳ 45/50/60  
 ↓ 75  
 ↙ 60

7

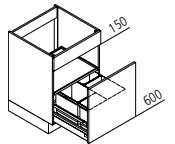

**SAB Spülenunterschrank mit Abfalltrennsystem**  
 ↳ 45/50/60/80/90/100/120  
 ↓ 75  
 ↙ 60

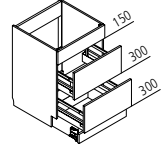

**SABS Spülenunterschrank mit Großraum-Sockelauszug**  
 ↳ 60/80/90/100  
 ↓ 75  
 ↙ 60

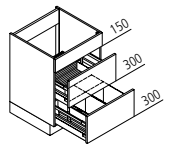

**SAKT Spülenunterschrank mit Abfalltrennsystem**  
 ↳ 60/80/90/100/120  
 ↓ 75  
 ↙ 60

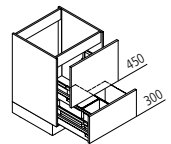

**SAZ Spülenunterschrank mit Abfalltrennsystem**  
 ↳ 60/80/90/100/120  
 ↓ 75  
 ↙ 60

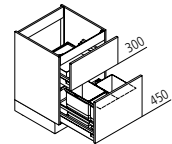

**SUZ Spülenunterschrank mit Abfalltrennsystem**  
 ↳ 60/80/90/100/120  
 ↓ 75  
 ↙ 60

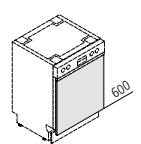

**GSB Türfront für integrierbare Geschirrspüler**  
 ↳ 45/60  
 ↓ 75  
 ↙ 60

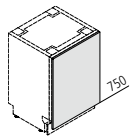

**GSBD Türfront für voll-integrierbare Geschirrspüler**  
 ↳ 45/60  
 ↓ 75  
 ↙ 60

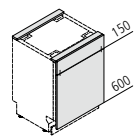

**GSBS Türfront für voll-integrierbare Geschirrspüler**  
 ↳ 45/60  
 ↓ 75  
 ↙ 60

Eckschränke

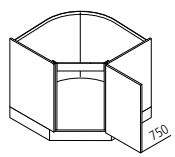

**UESD Spülenunterschrank-Ecke**  
 ↳ 90  
 ↓ 75  
 ↙ 60

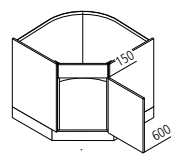

**UES Spülenunterschrank-Ecke**  
 ↳ 90  
 ↓ 75  
 ↙ 60

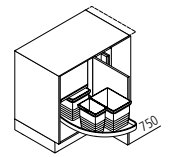

**UEPSZ Spülenunterschrank-Ausgleichsecke**  
 ↳ 110/115/125  
 ↓ 75  
 ↙ 60

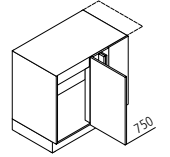

**UESAD Spülenunterschrank-Ausgleichsecke**  
 ↳ 110/115/125  
 ↓ 75  
 ↙ 60

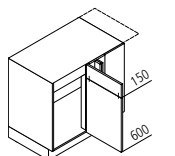

**UESA Spülenunterschrank-Ausgleichsecke**  
 ↳ 110/115/125  
 ↓ 75  
 ↙ 60

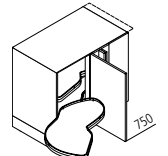

**UELAD Unterschrank-Ecke „LE MANS“**  
 ↳ 110/115/125  
 ↓ 75  
 ↙ 60

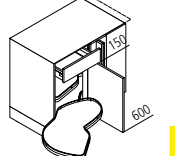

**UELA Unterschrank-Ecke**  
 ↳ 110/115/125  
 ↓ 75  
 ↙ 60

6

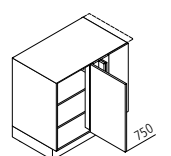

**UEEAD Unterschrank-Ecke**  
 ↳ 110/115/125  
 ↓ 75  
 ↙ 60/50

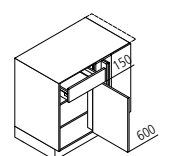

**UEEA Unterschrank-Ecke**  
 ↳ 110/115/125  
 ↓ 75  
 ↙ 60/50

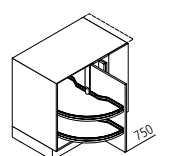

**UEAD Unterschrank-Ecke**  
 ↳ 110/115/125  
 ↓ 75  
 ↙ 60

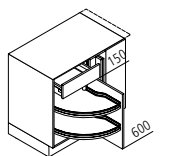

**UEA Unterschrank-Ecke**  
 ↳ 110/115/125  
 ↓ 75  
 ↙ 60

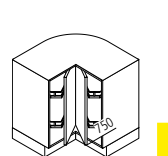

**UEK Unterschrank-Ecke**  
 ↳ 80/90  
 ↓ 75  
 ↙ 60

8

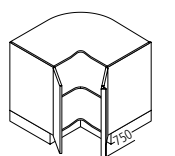

**UEKE Unterschrank-Ecke**  
 ↳ 80/90  
 ↓ 75  
 ↙ 60

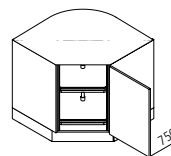

**UETD Unterschrank-Ecke**  
 ↳ 90  
 ↓ 75  
 ↙ 60

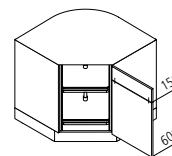

**UET Unterschrank-Ecke**  
 ↳ 90  
 ↓ 75  
 ↙ 60

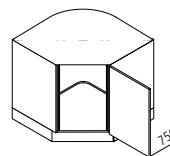

**UETDE Unterschrank-Ecke**  
 ↳ 90  
 ↓ 75  
 ↙ 60

Herd- und Kochstellenschränke

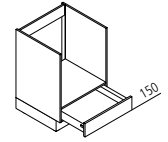

**UHSK Herdschrank mit Schubkasten**  
 ↳ 60  
 ↓ 75  
 ↙ 60

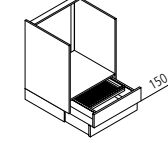

**UHS Herdschrank mit Großraumauszug**  
 ↳ 60  
 ↓ 75  
 ↙ 60

9

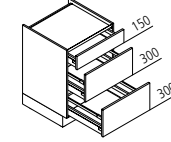

**KUAK Kochstellenschrank**  
 ↳ 60/80/90/100/120  
 ↓ 75  
 ↙ 60

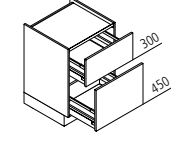

**KUZ Kochstellenschrank für Muldenlüfter**  
 ↳ 60/80/90/100/120  
 ↓ 75  
 ↙ 60

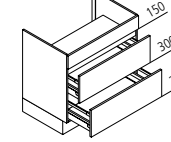

**KAK-ML Kochstellenschrank für Muldenlüfter**  
 ↳ 60/80/90/100/120  
 ↓ 75  
 ↙ 60

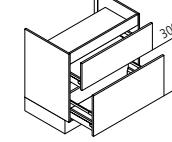

**KUZ Kochstellenschrank für Muldenlüfter**  
 ↳ 60/80/90/100/120  
 ↓ 75  
 ↙ 60

Generieren Sie Stauraum, wo sonst ungenutzter Raum entsteht: Der Sockelschubkasten macht's möglich.



6



8



9

Nolte Küchen bietet neben klassischen Abfalltrennsystemen auch Abfallsammler für Eckschränke oder sogar Möglichkeiten für die direkte Entsorgung der Vorbereitungsreste unterhalb der Arbeitsfläche.



7

# Unterschränke

900mm

# Vitrinen-Unterschränke

750 mm | 900 mm

900er Schränke

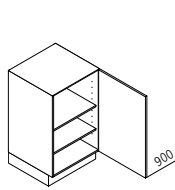

**UDD** Unterschrank  
↔ 30/40/45/50/60  
↓ 90  
↙ 60/50/39

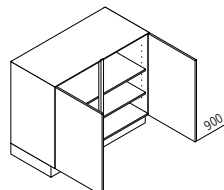

**UDD** Unterschrank  
↔ 80/90/100/120  
↓ 90  
↙ 60/50/39

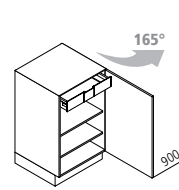

**UDDI** Unterschrank  
↔ 40/45/50/60  
↓ 90  
↙ 60/50

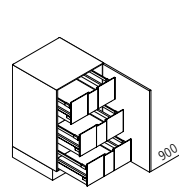

**UIADD** Unterschrank  
↔ 40/45/50/60  
↓ 90  
↙ 60/50/39

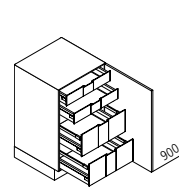

**UIDD** Unterschrank  
↔ 40/45/50/60  
↓ 90  
↙ 60/50/39

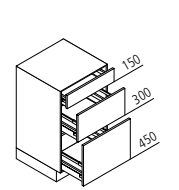

**UAK** Auszugsschrank  
↔ 30/40/45/50/60/80/90/100/120  
↓ 90  
↙ 60/50/39

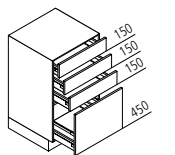

**UAS** Schubkastenschrank  
↔ 30/40/45/50/60/80/90/100  
↓ 90  
↙ 60/50/39

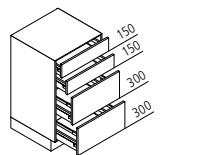

**USA** Schubkastenschrank  
↔ 30/40/45/50/60/80/90/100/120  
↓ 90  
↙ 60/50/39

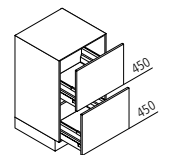

**UZ** Auszugsschrank  
↔ 30/40/45/50/60/80/90/100/120  
↓ 90  
↙ 60/50/39

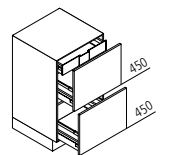

**UZI** Auszugsschrank  
↔ 30/40/45/50/60/80/90/100/120  
↓ 90  
↙ 60/50/39

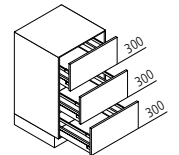

**UAZ** Auszugsschrank  
↔ 30/40/45/50/60/80/90/100/120  
↓ 90  
↙ 60/50/39

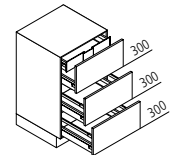

**UAZI** Auszugsschrank  
↔ 30/40/45/50/60/80/90/100/120  
↓ 90  
↙ 60/50/39

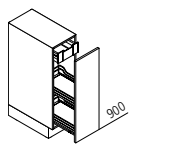

**UVKI** Auszugsschrank mit Vorratskörben  
↔ 30  
↓ 90  
↙ 60

Eckschrank

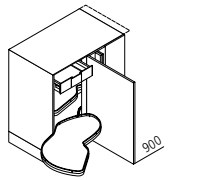

**UELADI** Unterschrank-Ausgleichscke „LE MANS“  
↔ 110/115/125  
↓ 90  
↙ 60

Spülenschränke

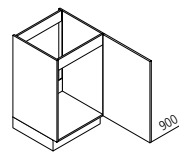

**SOD** Spülenunterschrank  
↔ 45/50/60  
↓ 90  
↙ 60

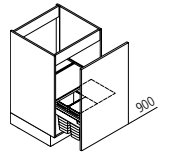

**SABHD** Spülenunterschrank mit Abfalltrennsystem  
↔ 45/50/60  
↓ 90  
↙ 60

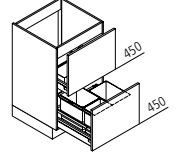

**SUZ** Spülenunterschrank mit Abfalltrennsystem  
↔ 60/80/90/100/120  
↓ 90  
↙ 60

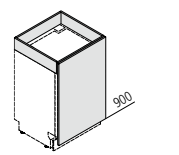

**GSBD** Türfront für voll-integrierbare Geschirrspüler  
↓ 60  
↓ 90  
↙ 60

Herd- und Kochstellenschränke

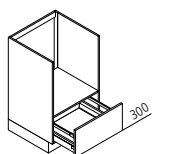

**UHAZ** Herdschrank  
↔ 60  
↓ 90  
↙ 60

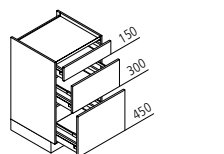

**KUAK** Kochstellenschrank  
↔ 60/80/90/100/120  
↓ 90  
↙ 60

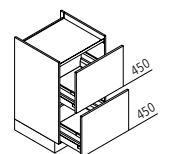

**KUZ** Kochstellenschrank  
↔ 60/80/90/100/120  
↓ 90  
↙ 60

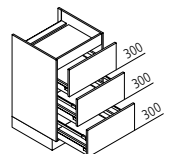

**KAZ** Kochstellenschrank  
↔ 60/80/90/100/120  
↓ 90  
↙ 60

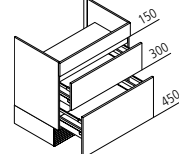

**KAK-ML** Kochstellenschrank für Muldenlüfter  
↔ 60/80/90/100/120  
↓ 75  
↙ 60

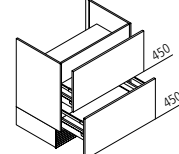

**KUZ** Kochstellenschrank für Muldenlüfter  
↔ 60/80/90/100/120  
↓ 75  
↙ 60

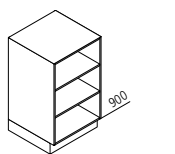

**UR** Unterschrank-Regal  
↔ 15/20/25/30/35/40/45/50/55/60  
↓ 90  
↙ 60/39

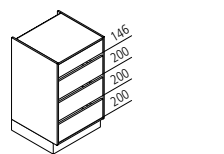

**URI** Unterschrank-Regal mit Schubkästen  
↔ 60/90  
↓ 90  
↙ 60/39

**MATRIX900**  
by **notte** KÜCHEN

Die 900 mm Korpushöhe bietet die perfekte Verbindung von Ergonomie und Design. Sie sorgt mit dem schlanken Sockel nicht nur für eine völlig neue Optik, sondern setzt auch in Punkto Stauraum und Ergonomie neue Maßstäbe. Besonders in Kombination mit 600 mm hohen Unterschrankelementen lassen sich so interessante Planungen gestalten.

Vitrinen

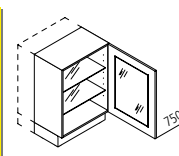

**UDDV** Unterschrank mit Glasstür (programmabhängig)  
↔ 40/45/50/60  
↓ 75/90  
↙ 60/39

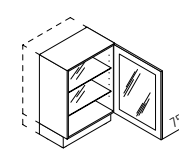

**UDDDS** Unterschrank mit Glasstür **DS**  
↔ 40/45/50/60  
↓ 75/90  
↙ 60/39

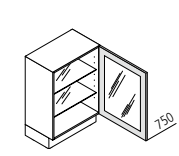

**UDDDN** Unterschrank mit Glasstür **DN**  
↔ 40/45/50/60  
↓ 75/90  
↙ 39

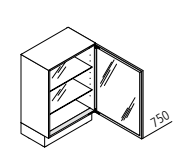

**UDDDR** Unterschrank mit Glasstür **DR**  
↔ 40/45/50/60  
↓ 75/90  
↙ 39

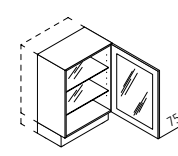

**UDDDF** Unterschrank mit Glasstür **DF**  
↔ 40/45/50/60  
↓ 75/90  
↙ 60/39

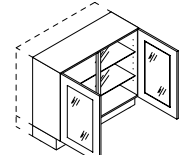

**UDDV** Unterschrank mit Glasstür (programmabhängig)  
↔ 80/90/100/120  
↓ 75/90  
↙ 60/39

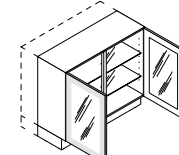

**UDDDS** Unterschrank mit Glasstür **DS**  
↔ 80/90/100/120  
↓ 75/90  
↙ 60/39

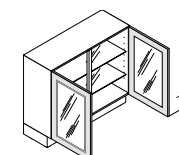

**UDDDN** Unterschrank mit Glasstür **DN**  
↔ 80/90/100/120  
↓ 75/90  
↙ 39

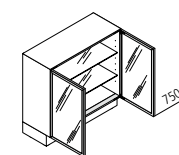

**UDDDR** Unterschrank mit Glasstür **DR**  
↔ 80/90/100/120  
↓ 75/90  
↙ 39

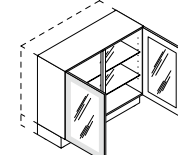

**UDDDF** Unterschrank mit Glasstür **DF**  
↔ 80/90/100/120  
↓ 75/90  
↙ 60/39

**Hinweis:**  
Vitrinen mit einer Korpushöhe von 90 cm sind nur in der Korpushöhe 39 cm lieferbar!

# Vitrinen-Glas- & Rahmenausführungen

Glasausführungen

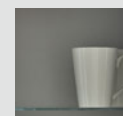

**KAG**  
Klarglas

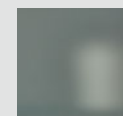

**SAG**  
Glas satiniert

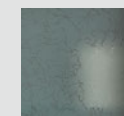

**FRE**  
Glas Freeze

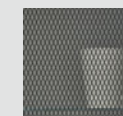

**KDG**  
Klarglas Draht-optik schwarz



**SGG**  
Glas Schwarz getönt

Die hier gezeigten Glasausführungen können bei den programmabhängigen Glasstüren gewählt werden.

Rahmenausführung DF



**WLG**  
Glas Weiß lackiert

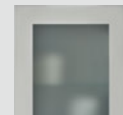

**SWG**  
Glas satiniert / Grau

Rahmenausführung DS

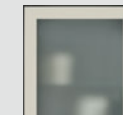

**SAG**  
Glas satiniert



**PGG**  
Parsolglas Grau

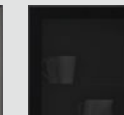

**SGG**  
Glas Schwarz getönt

Rahmenausführung DN

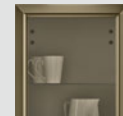

**PGB**  
Parsolglas Bronze mit Alurahmen



**SGG**  
Glas Schwarz getönt mit Alurahmen

Rahmenausführung DR



**KAG**  
Klarglas mit schmalem Alurahmen



**SGG**  
Glas Schwarz getönt, mit schmalem Alurahmen

1



# Hängeschränke

300 | 450 | 600 | 750 | 900

1050 | 1200 | 1350 mm

# Vitrinen-Hängeschränke

300 | 450 | 600 | 750 | 900

1050 | 1200 | 1350 mm

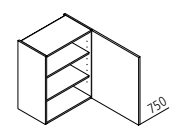

**H Hängeschrank**

↔ 30/40/45/50/60  
↓ 45/60/75/90/105/120/135  
↙ 35/60\*

\* = nur bis 90 cm Höhe lieferbar

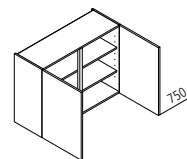

**H Hängeschrank**

↔ 80/90/100/120  
↓ 45/60/75/90  
↙ 35/60\*

\* = nur bis 90 cm Höhe lieferbar

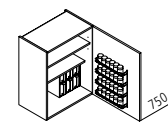

**HGL Gewürzschrank**

↔ 30/40/45/50/60  
↓ 60/75/90  
↙ 35

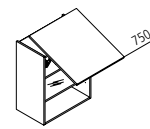

**HL Schwebeklappenschrank**

↔ 45/50/60/80/90/100/120\*  
↓ 60/75  
↙ 35/60

\* = nur in 60 cm Höhe lieferbar

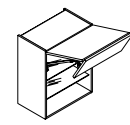

**HFK Faltklappenschrank**

↔ 45/50/60/80/90/100/120\*  
↓ 60/75  
↙ 35/60

\* = nur in 60 cm Höhe lieferbar

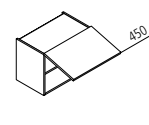

**HK Hängeschrank**

↔ 45/50/60/80/90/100/120  
↓ 45  
↙ 35/60



1



2

Neben den programmabhängigen Glastüren verfügen Sie auch noch über weitere Gestaltungsvarianten. Die verschiedenen Glas- und Rahmenausführungen entnehmen Sie bitte der Seite 45.

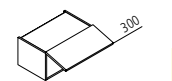

**H Hängeschrank**

↔ 30/40/45/50/60/80/90/100/120  
↓ 30  
↙ 35/60

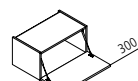

**HBF Hängeschrank mit Barklappe**

↔ 60/80/90/100/120  
↓ 30/45  
↙ 35/50

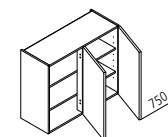

**HEK Hängeschrank**

↔ 80/90  
↓ 60/75/90  
↙ 35

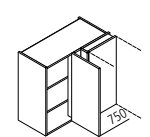

**HES Hängeschrank-Ecke**

↔ 80/90  
↓ 60/75/90  
↙ 35

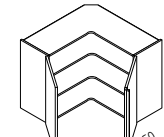

**HE Hängeschrank-Ecke**

↔ 65/80/90  
↓ 60/75/90  
↙ 35

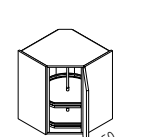

**HET Hängeschrank-Ecke**

↔ 60  
↓ 60/75/90  
↙ 35

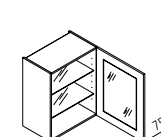

**HV Hängeschrank mit Glastür (programmabhängig)**

↔ 40/45/50/60  
↓ 60/75/90  
↙ 35

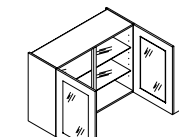

**HV Hängeschrank mit Glastür (programmabhängig)**

↔ 80/90/100/120  
↓ 60/75/90  
↙ 35

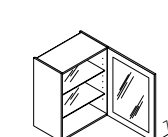

**HVDS Hängeschrank mit Glastür DS**

↔ 40/45/50/60  
↓ 60/75/90/105  
↙ 35

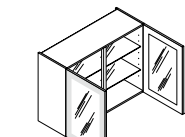

**HVDS Hängeschrank mit Glastür DS**

↔ 80/90/100/120  
↓ 60/75/90  
↙ 35

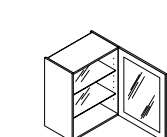

**HVDF Hängeschrank mit Glastür DF**

↔ 40/45/50/60  
↓ 60/75/90  
↙ 35

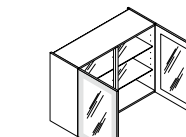

**HVDF Hängeschrank mit Glastür DF**

↔ 80/90/100/120  
↓ 60/75/90  
↙ 35

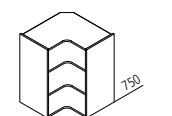

**HER Hängeschrank-Eckregal**

↔ 60/65  
↓ 60/75/90  
↙ 35

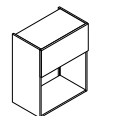

**HM Hängeschrank für Mikrowelle**

↔ 50/60  
↓ 60/75/90/105  
↙ 35

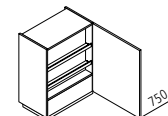

**HWU Hängeschrank für integrierte Abzughaube**

↔ 60  
↓ 45/60/75/90/105  
↙ 35

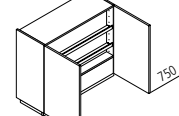

**HWU Hängeschrank für integrierte Abzughaube**

↔ 90  
↓ 45/60/75/90/105  
↙ 35

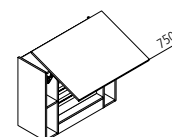

**HWUL Schwebeklappenschrank für integrierte Abzughaube**

↔ 80/90/100/120\*  
↓ 60/75  
↙ 35

\* = nur in 60 cm Höhe lieferbar

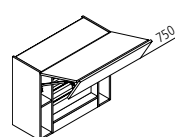

**HWUFK Faltklappenschrank für integrierte Abzughaube**

↔ 80/90/100/120\*  
↓ 60/75  
↙ 35

\* = nur in 60 cm Höhe lieferbar

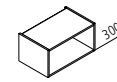

**HR Hängeschrank-Regal**

↔ 30/40/45/50/60/80/90/100/120  
↓ 30  
↙ 35



**HRV Hängeschrank-Regal mit Glasböden**

↔ 60/90/120  
↓ 30/45  
↙ 35

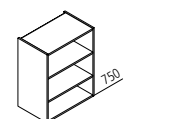

**HR Hängeschrank-Regal**

↔ 15/20/25/30/35/40/45/50/55/60  
↓ 45/60/75/90/105  
↙ 35

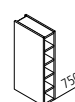

**HF Hängeschrank-Flaschenregal**

↔ 15  
↓ 60/75/90  
↙ 35

Dank Matrix 150 bieten die 350 mm tiefen Hängeschränke sogar Platz für große Pastateller.

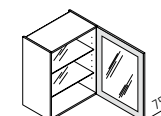

**HVDN Hängeschrank mit Glastür DN**

↔ 40/45/50/60  
↓ 60/75/90/105  
↙ 35

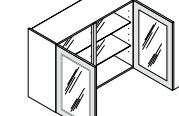

**HVDN Hängeschrank mit Glastür DN**

↔ 80/90/100/120  
↓ 60/75/90  
↙ 35

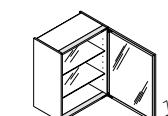

**HVDR Hängeschrank mit Glastür DR**

↔ 40/45/50/60  
↓ 60/75/90/105/120/135  
↙ 35

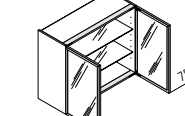

**HVDR Hängeschrank mit Glastür DR**

↔ 80/90/100/120  
↓ 60/75/90  
↙ 35

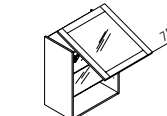

**HLV Schwebeklappenschrank mit Glastür (programmabhängig)**

↔ 45/50/60/80/90/100/120\*  
↓ 60/75  
↙ 35

\* = nur in 60 cm Höhe lieferbar

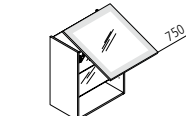

**HLDS Schwebeklappenschrank mit Glas DS**

↔ 45/50/60/80/90/100/120\*  
↓ 60/75  
↙ 35

\* = nur in 60 cm Höhe lieferbar

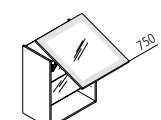

**HLDf Schwebeklappenschrank mit Glas DF**

↔ 45/50/60/80/90/100/120\*  
↓ 60/75  
↙ 35

\* = nur in 60 cm Höhe lieferbar

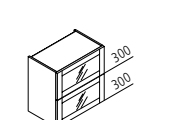

**HFkV Faltklappenschrank mit Glastür (programmabhängig)**

↔ 45/50/60/80/90/100/120  
↓ 60  
↙ 35

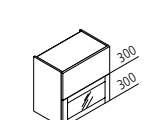

**HFkVPU Faltklappenschrank mit Glastür (programmabhängig)**

↔ 45/50/60/80/90/100/120  
↓ 60/75  
↙ 35

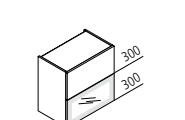

**HFkDSPU Faltklappenschrank mit Glas DS**

↔ 45/50/60/80/90/100/120  
↓ 60/75  
↙ 35

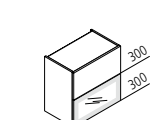

**HFkDPU Faltklappenschrank mit Glas DF**

↔ 45/50/60/80/90/100/120  
↓ 60/75  
↙ 35

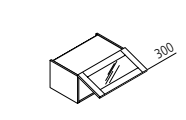

**HV Hängeschrank mit Glastür (programmabhängig)**

↔ 45/50/60/80/90/100/120  
↓ 30  
↙ 35



**HVDS Hängeschrank mit Glas DS**

↔ 45/50/60/80/90/100/120  
↓ 30  
↙ 35

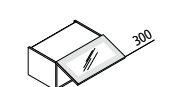

**HVDF Hängeschrank mit Glas DF**

↔ 45/50/60/80/90/100/120  
↓ 30  
↙ 35

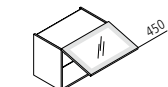

**HKDS Hängeschrank mit Glas DS**

↔ 60/80/90/100/120  
↓ 45  
↙ 35

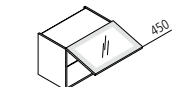

**HKDF Hängeschrank mit Glas DF**

↔ 60/80/90/100/120  
↓ 45  
↙ 35

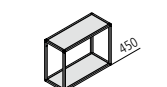

**HRALU Regalsystem Aluminium Schwarz a. Edelstahl-Optik**

↔ 60/90/120  
↓ 30/45/60  
↙ 35

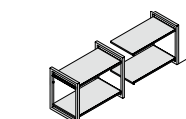

**HRM Regalsystem Metall Schwarz - erweiterbar**

↔ 60  
↓ 45  
↙ 35

## Aufsatzschränke

1150 | 1300 | 1450 mm

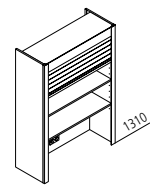

**H AJ** Aufsatzschrank mit Jalousie in Metall-Optik  
 ↳ 50/60/80/90  
 ↓ 115/130/145  
 ↶ 35/50/60

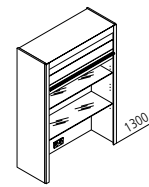

**H AJGO** Aufsatzschrank mit Jalousie in Glas-Optik  
 ↳ 60/90  
 ↓ 115/130/145  
 ↶ 35/50/60  
 Lieferbar in Schwarz softmatt oder Schwarz Hochglanz

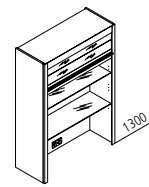

**H AJV** Aufsatzschrank mit Jalousie in Glas-Optik  
 ↳ 50/60/80/90  
 ↓ 115/130/145  
 ↶ 35/50/60

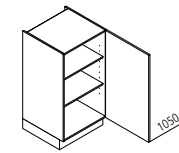

**V** Vorratsschrank  
 ↳ 30/40/45/50/60  
 ↓ 105  
 ↶ 60/50/35

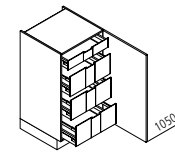

**VI** Vorratsschrank  
 ↳ 40/45/50/60  
 ↓ 105  
 ↶ 60/50/35

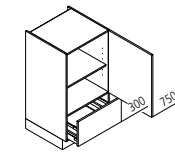

**VA** Vorratsschrank  
 ↳ 30/40/45/50/60  
 ↓ 105  
 ↶ 60/50

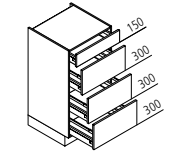

**VAK** Vorratsschrank  
 ↳ 30/40/45/50/60  
 ↓ 105  
 ↶ 60/50

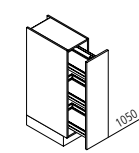

**VVA** Vorratsschrank  
 ↳ 30/40  
 ↓ 105  
 ↶ 60

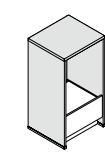

**WA-GUB** Wangenumbau für hochgebauten Geschirrspüler  
 ↳ 60  
 ↓ 105  
 ↶ 60

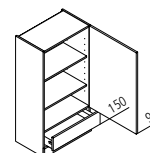

**HASK** Aufsatzschrank  
 ↳ 45/50/60  
 ↓ 115/  
 ↶ 35

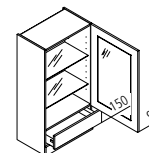

**HASKV** Aufsatzschrank mit Glasür (programmabhängig)  
 ↳ 45/50/60  
 ↓ 115  
 ↶ 35

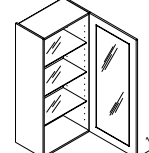

**HAVDN** Aufsatzschrank mit Glasür DN  
 ↳ 45/50/60  
 ↓ 115/130/145  
 ↶ 35

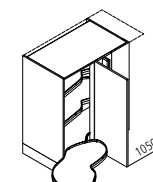

**VELA** Vorratsschrank-Ecke  
 ↳ 110/115/125  
 ↓ 105  
 ↶ 60

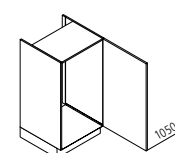

**GK** Geräteschrank für Kühlschrank / Nische 1025 mm  
 ↳ 60  
 ↓ 105  
 ↶ 60

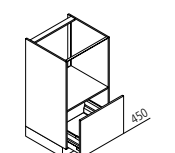

**GBZ** Geräteschrank für Backofen oder Mikrowelle  
 ↳ 60  
 ↓ 105  
 ↶ 60

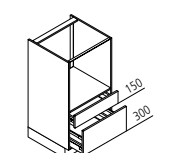

**GBAS** Geräteschrank für Backofen oder Mikrowelle  
 ↳ 60  
 ↓ 105  
 ↶ 60

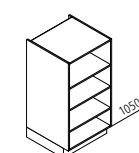

**SR** Regal  
 ↳ 20/25/30/40/45/50/60  
 ↓ 105  
 ↶ 60

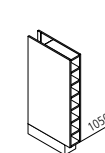

**SF** Flaschenregal  
 ↳ 15  
 ↓ 105  
 ↶ 60

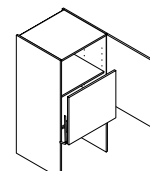

**HAL** Aufsatzschrank mit Lifttür  
 ↳ 60  
 ↓ 115/130/145  
 ↶ 60

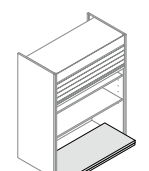

**HAAB** Ausziehboden mit TipOn für Aufsatzschränke  
 ↳ 50/60/80/90  
 ↶ 50/60

### Planungstipp:

Die endgültige Höhe der hier gezeigten Aufsatzschränke wird automatisch an die Arbeitsplattenstärke angepasst!



Machen Sie Ihre Geräteschränke einfach zum Sideboard: Die Seitenschrankhöhe von 1050 mm gibt Ihnen noch mehr Möglichkeiten bei der offenen Gestaltung der Küche.



# Vorrats- und Geräteschränke

1350 | 1500 mm

Die Zeichnungen zeigen  
Korpshöhe 1500 mm.

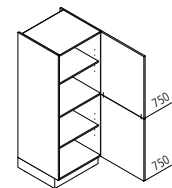

**V Vorratsschrank**  
↔ 30/40/45/50/60  
↓ 135/150  
↶ 60/50/35

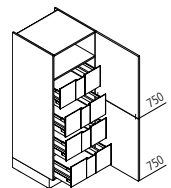

**VI Vorratsschrank**  
↔ 40/45/50/60  
↓ 135/150  
↶ 60/50/35

1

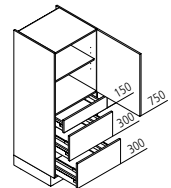

**VAK Vorratsschrank**  
↔ 30/40/45/50/60  
↓ 135/150  
↶ 60/50

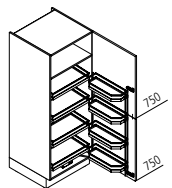

**VVK Vorratsschrank**  
↔ 60  
↓ 135/150  
↶ 60

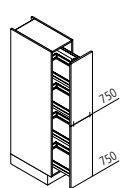

**VVA Vorratsschrank**  
↔ 30/40  
↓ 135/150  
↶ 60

1



2



3



4

# Vorrats- und Geräteschränke

1950 | 2100 | 2250 mm

Die Zeichnungen zeigen  
Korpshöhe 1500 mm.

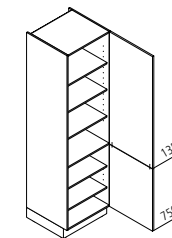

**V Vorratsschrank**  
↔ 30/40/45/50/60  
↓ 195/210/225  
↶ 60/50/35

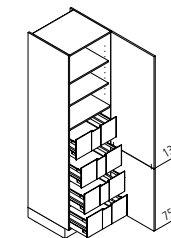

**VI Vorratsschrank**  
↔ 40/45/50/60  
↓ 195/210/225  
↶ 60/50/35

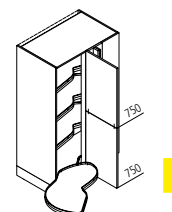

**VELA Vorratsschrank-Ecke**  
↔ 110/115/125  
↓ 135/150  
↶ 60

2

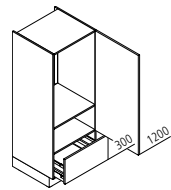

**GKA Geräteschrank für Kühlschrank / Nische 880 mm**  
↔ 60  
↓ 135/150  
↶ 60

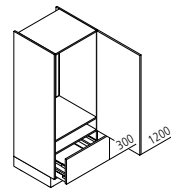

**GKA Geräteschrank für Kühlschrank / Nische 1025 mm**  
↔ 60  
↓ 135/150  
↶ 60

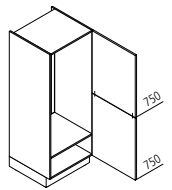

**GK Geräteschrank für Kühlschrank / Nische 1225 mm**  
↔ 60  
↓ 135/150  
↶ 60

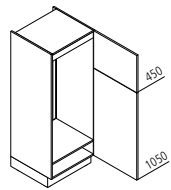

**GKG Geräteschrank für Kühl-Gefrierkombination / Nische 1225 mm**  
↔ 60  
↓ 135/150  
↶ 60

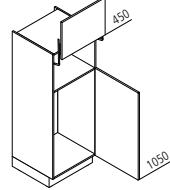

**GKL Geräteschrank mit Lifttür für Kühlschrank, Mikrowelle / Nische 880 mm**  
↔ 60  
↓ 135/150  
↶ 60

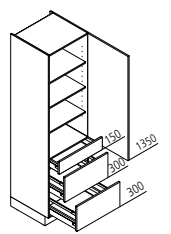

**VAK Vorratsschrank**  
↔ 30/40/45/50/60  
↓ 195/210/225  
↶ 60/50

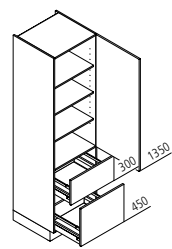

**VZ Vorratsschrank**  
↔ 30/40/45/50/60  
↓ 195/210/225  
↶ 60/50

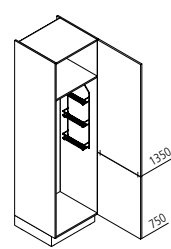

**VB Besenschrank**  
↔ 30/40/45/50/60  
↓ 195/210/225  
↶ 60/50

3

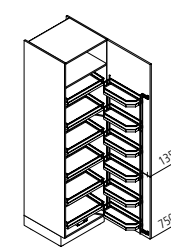

**VVK Vorratsschrank**  
↔ 60  
↓ 195/210/225  
↶ 60

4

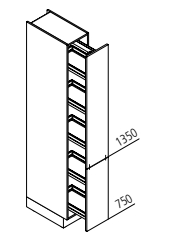

**VVA Vorratsschrank**  
↔ 30/40  
↓ 195/210/225  
↶ 60

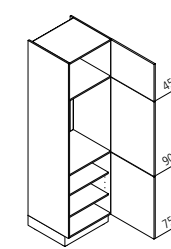

**GK Geräteschrank für Kühlschrank / Nische 880 mm**  
↔ 60  
↓ 195/210/225  
↶ 60

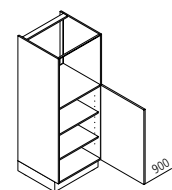

**GB Geräteschrank für Backofen oder Mikrowelle**  
↔ 60  
↓ 135/150  
↶ 60

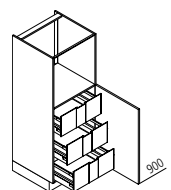

**GBI Geräteschrank für Backofen oder Mikrowelle**  
↔ 60  
↓ 135/150  
↶ 60

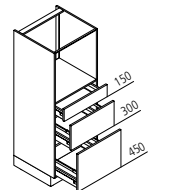

**GBZ Geräteschrank für Backofen oder Mikrowelle**  
↔ 60  
↓ 135/150  
↶ 60

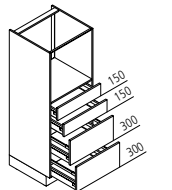

**GBAK Geräteschrank für Backofen oder Mikrowelle**  
↔ 60  
↓ 135/150  
↶ 60

## Planungsinfo!

Diesem Beispiel können Sie entnehmen, wie sich die Schränke in der jeweiligen Korpushöhe verändern:

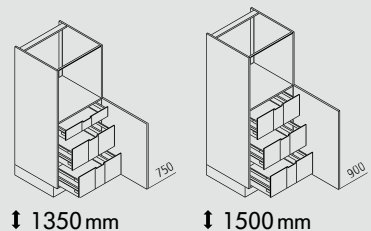

Geräteschränke passen sich immer den eingebauten Geräten an. Je nach Hersteller und Gerätehöhe können sich die hier abgebildeten Schränke in Punkto Frontaufteilungen und Anzahl von Schubkästen oder Auszügen verändern.

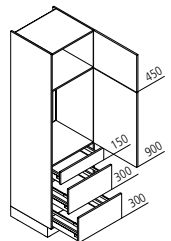

**GKAK Geräteschrank für Kühlschrank / Nische 880 mm**  
↔ 60  
↓ 195/210/225  
↶ 60

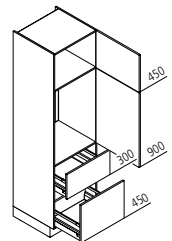

**GKZ Geräteschrank für Kühlschrank / Nische 880 mm**  
↔ 60  
↓ 195/210/225  
↶ 60

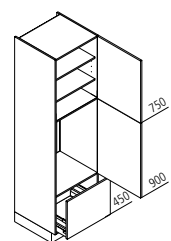

**GKA Geräteschrank für Kühlschrank / Nische 880 mm**  
↔ 60  
↓ 195/210/225  
↶ 60

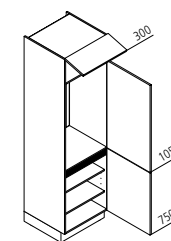

**GK Geräteschrank für Kühlschrank / Nische 1025 mm**  
↔ 60  
↓ 195/210/225  
↶ 60

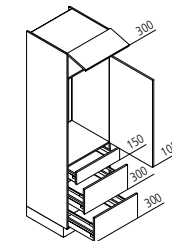

**GKAK Geräteschrank für Kühlschrank / Nische 1025 mm**  
↔ 60  
↓ 195/210/225  
↶ 60

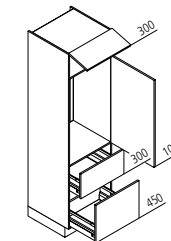

**GKZ Geräteschrank für Kühlschrank / Nische 1025 mm**  
↔ 60  
↓ 195/210/225  
↶ 60

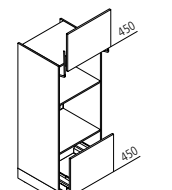

**GBLA Geräteschrank mit Lifttür für Backofen und Mikrowelle**  
↔ 60  
↓ 135/150  
↶ 60

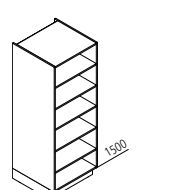

**SR Regal**  
↔ 20/25/30/35/40/45/50/55/60  
↓ 135/150  
↶ 60

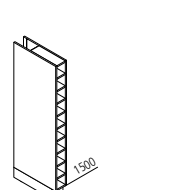

**SF Flaschenregal**  
↔ 15  
↓ 135/150  
↶ 60

Damit Sie in dem umfangreichen Angebot an Vorrats- und Geräteschränken nicht den Überblick verlieren, haben wir die lieferbaren Korpushöhen hier in einer Abbildung zusammengefasst und bilden nur eine Auswahl an Geräteschränken ab.

# Vorrats- und Geräteschränke

1950 | 2100 | 2250 mm

Die Zeichnungen zeigen  
Korpushöhe 2100 mm.

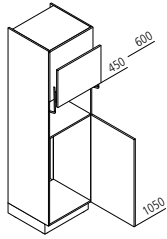

**GKL** Geräteschrank mit Lifttür  
für Kühlschrank, Mikrowelle /  
Nische 1025 mm  
↔ 60  
↓ 195/210/225  
↙ 60

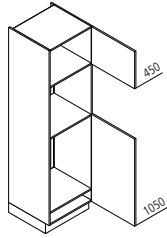

**GKB** Geräteschrank für Kühl-  
schrank und Backofen /  
Nische 880 mm  
↔ 60  
↓ 195/210/225  
↙ 60

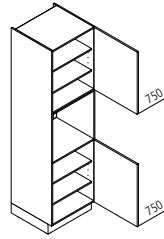

**GB** Geräteschrank für  
Backofen / Mikrowelle  
↔ 60  
↓ 195/210/225  
↙ 60

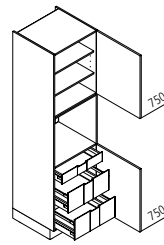

**GBI** Geräteschrank für  
Backofen / Mikrowelle  
↔ 60  
↓ 195/210/225  
↙ 60

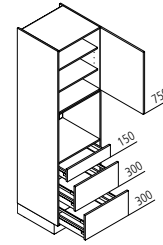

**GBAK** Geräteschrank für  
Backofen / Mikrowelle  
↔ 60  
↓ 195/210/225  
↙ 60

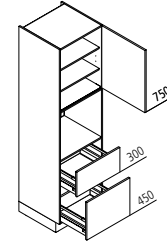

**GBZ** Geräteschrank für  
Backofen / Mikrowelle  
↔ 60  
↓ 195/210/225  
↙ 60

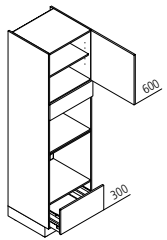

**GBBA** Geräteschrank für  
Backofen / Mikrowelle  
↔ 60  
↓ 195/210/225  
↙ 60

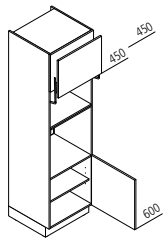

**GBL** Geräteschrank mit Lifttür  
für Backofen / Mikrowelle  
↔ 60  
↓ 195/210/225  
↙ 60

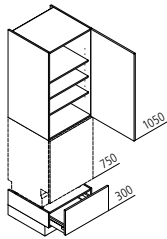

**GGSAB** Geräteschrankumbau  
für Geschirrspüler  
↔ 60  
↓ 195/210/225  
↙ 60

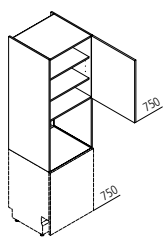

**GGSB** Geräteschrankumbau  
für Geschirrspüler / Backofen  
↔ 60  
↓ 195/210/225  
↙ 60

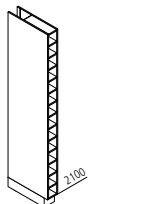

**SF** Flaschenregal  
↔ 15  
↓ 195/210/225  
↙ 60

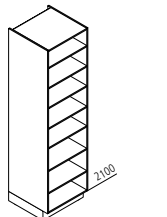

**SR** Regal  
↔ 20/25/30/35/40/45/50/55/60  
↓ 195/210/225  
↙ 60

## Planungsinfo!

Damit Sie in dem umfangreichen Angebot den Überblick behalten, haben wir hier die lieferbaren Korpushöhen in einer Abbildung zusammengefasst und bilden nur eine Auswahl an Geräteschränken ab.

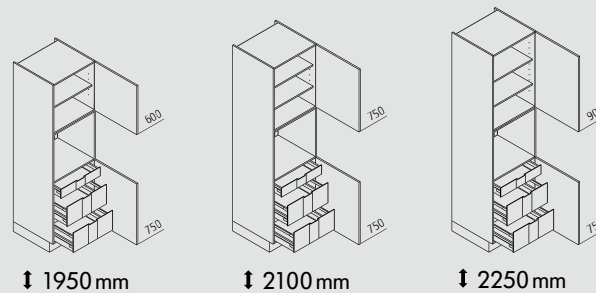

Dem Beispiel links können Sie entnehmen, wie sich die Schränke in der jeweiligen Korpushöhe verändern:

Geräteschränke passen sich immer den eingebauten Geräten an. Je nach Hersteller und Gerätehöhe können sich die hier abgebildeten Schränke in Punkto Frontaufteilungen und Anzahl von Schubkästen oder Auszügen verändern.

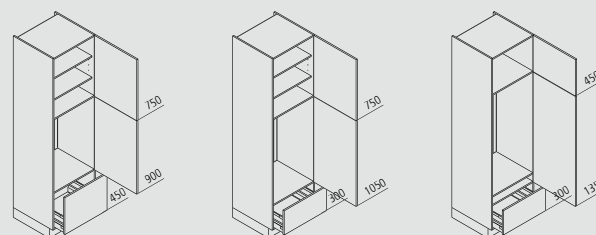

Als Beispiel ein Geräteschrank für einen Kühlschrank in 2100 mm Höhe mit den Nischenhöhen 880, 1025 und 1225 mm (von links).